



F E D E R I C A  
**BUGATTI**

## INSTRUCTION MANUAL

Heating systems • Federica Bugatti

series **VARME**

12 18 24 28 32

Safe. Reliable. Warm.



FEDERICA BUGATTI LLC.  
MANUFACTURER: VARMECOM INC., MADE IN TURKEY

[FEDERICABUGATTI.COM](http://FEDERICABUGATTI.COM)



**Table of contents**

<i>Scope of delivery</i> .....	2	<i>Conversion to a different type of gas</i> .....	25
<i>Introduction</i> .....	2	<i>Parameter adjustments (Technical menu)</i> .....	27
<i>List of safety signs</i> .....	3	<i>Information menu</i> .....	28
<i>Technician in charge of installation</i> .....	3	<i>Technical features</i> .....	29
<i>Installation, usage, maintenance</i> .....	3	<i>Warranty card</i> .....	30
<b>User Manual</b>		<i>About maintenance</i> .....	30
<i>General safety rules for the usage</i> .....	4	<i>Operations to be performed during regular</i>	
<i>Disposal of the product</i> .....	4	<i>maintenance</i> .....	31
<i>Precautions to take before initiating the</i>		<i>Remarks on scheduled maintenance</i> .....	31
<i>boiler</i> .....	4	<i>Warranty conditions</i> .....	32
<i>Switching on the boiler and adjusting</i>			
<i>operation modes</i> .....	5		
<i>DHW temperature adjustment</i> .....	5		
<i>Features of the DHW, DCW, and, heating</i>			
<i>circuit</i> .....	5		
<i>Inadequate hot water productivity (DHW)</i> .....	6		
<i>Heating circuit temperature adjustment</i> .....	6		
<i>Operating principle of the heating circuit</i> .....	6		
<i>Function of the heating circuit connected with</i>			
<i>an outdoor air sensor</i> .....	7		
<i>Precautionary functions</i> .....	7		
<i>Filling and adjusting the heating circuit</i>			
<i>pressure</i> .....	8		
<i>Button assignments, representation of the</i>			
<i>indicators on the display</i> .....	8		
<i>Description of the indicators, which display the</i>			
<i>status of the boiler</i> .....	9		
<i>Draining the system</i> .....	10		
<i>Prolonged inactive state of the boiler and</i>			
<i>"Anti-freeze" function</i> .....	10		
<i>Faults in boiler operation and how to eliminate</i>			
<i>them</i> .....	11		
<i>Possible malfunctions of the boiler</i> .....	11		
<i>Absence of flame at the burner</i> .....	11		
<i>Error codes appearing on the display</i> .....	12		
<b>Technician Manual</b>			
<i>Internal components of the boiler</i> .....	14		
<i>Hydraulic diagram</i> .....	15		
<i>Placement of the boiler</i> .....	16		
<i>Positioning and mounting the boiler</i> .....	16		
<i>Gas connection</i> .....	16		
<i>Power connection</i> .....	17		
<i>Electrical circuit diagram</i> .....	18		
<i>Chimney connections, general</i>			
<i>recommendations</i> .....	19		
<i>Diaphragm for abbreviated systems</i> .....	19		
<i>Types of flue gas ventilation and air intake</i>			
<i>systems</i> .....	20		
<i>Various chimney configurations</i> .....	21		
<i>Overall connection measurements</i> .....	22		
<i>Diagram for determining the remaining</i>			
<i>pressure inside of pump, and pump</i>			
<i>adjustments</i> .....	22		
<i>Operations to be performed before</i>			
<i>commissioning the boiler</i> .....	23		
<i>Access to the internal parts of the boiler</i> .....	24		
<i>Gas pressure inlet check, adjustment of max.</i>			
<i>and min. gas pressure at the burner</i> .....	24		

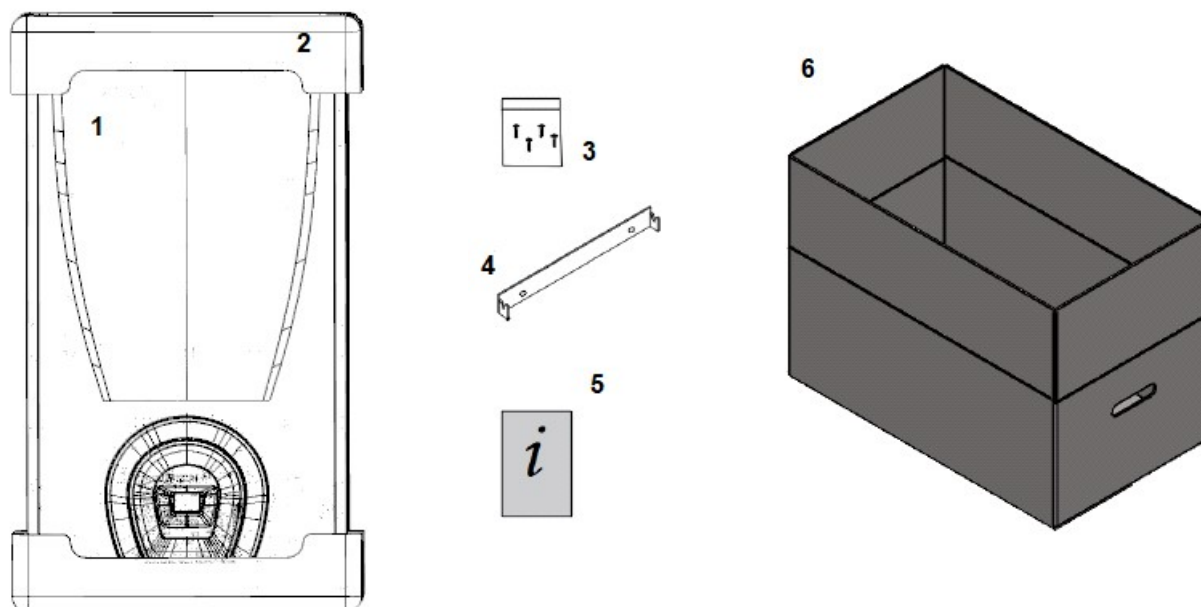
**Scope of delivery**

- 1 – gas heating boiler
- 2 – styrofoam
- 3 – fixing material (screws with accessories)
- 4 – hinge bar
- 5 – printed documentation set
- 6 – box

**Introduction**

**This operating manual is an integral and supplementary part of the product and is supplied with the boiler.**







Read the instruction manual carefully for all important information for the safe installation, operation, and maintenance of the equipment.

- *The dangers of carbon monoxide (CO): CO is an odourless and colourless gas. When installing a boiler with room air intake (type B2), constant ventilation of the room is extremely important. Ventilation must be carried out following applicable regulations. Covering or neutralizing ventilation can lead to serious health issues, such as carbon monoxide poisoning, irreversible organ damage, and even death. In addition, a mixture of CO and O<sub>2</sub> can be explosive.*
- *A qualified technician is a person with specialized technical training and experience in the installation of domestic heating appliances and acts in accordance with the norms and regulations.*
- *The user can only perform the operations listed in the "User Manual" section.*
- *The manufacturer accepts no responsibility for damage caused by incorrect installation, improper use, and non-compliance with the applicable regulations and instructions.*
- **ATTENTION!** *A gas boiler is used for heating the water to a temperature below boiling point at atmospheric pressure and must be connected to a heating and/or hot water supply system according to its characteristics and capacity.*
- *Packaging objects (cardboard, nails, plastic bags, etc.) must not be left within the reach of children, as it may be dangerous.*
- *Before any cleaning or maintenance of the boiler, disconnect it from the mains and switch off the gas valve.*
- *In the event of a malfunction and/or an improper operation of the appliance, disconnect it immediately and do not attempt to repair it by yourself.*
- *The boiler must be serviced and repaired only by qualified personnel using original spare parts. The requirement must be strictly observed.*
- *If the appliance needs to be dismantled, remove any remaining dangerous objects and dispose of them by the regulations in force.*
- *When relocating the unit (e.g. moving), make sure that the operating instructions are maintained and*

handed over to the future owner and/or installer.

- This appliance should only be used for strictly recommended purposes. Any other use is considered dangerous and improper.
- It is strictly forbidden to use the equipment for other than the intended purpose.
- The appliance must be mounted exclusively on the wall.
- The instruction manual is an important part of the product and is supplied with it.
- Read the instructions carefully, applying all information for the safe installation, use, and maintenance of the appliance.
- Installation must be carried out by a qualified technician in accordance with the requirements of the regulations and manufacturer's instructions.

### List of safety signs

	General safety warning		Electrical hazard		Physical hazard
	Thermal hazard		General warnings to avoid damage and recommendations for improvement		

### Technician in charge of installation

Always comply with the safety standards and regulations of the applicable local public authorities and health authorities. Always be careful when handling the boiler and performing installation/maintenance work to avoid injuries such as cuts and abrasions. Use personal protective equipment (especially gloves) when performing the operations. The boiler installation process, the requirements for operating the room, and its ventilation must strictly comply with the applicable legal standards and regulations. The qualified technician is obliged to inform the user about the operating and safety rules after installation of the equipment and to hand over the present instruction manual to the user.

### Installation, usage, and maintenance



All operations, such as installation, initial start-up, maintenance, repair, and gas adjustment must be carried out by qualified technicians in accordance with the applicable standards and laws. Maintenance operations must be carried out in accordance with the manufacturer's instructions and in compliance with the applicable laws and regulations. To guarantee the efficiency and proper operation of the boiler, annual maintenance is a mandatory requirement.

#### Resource and service life under the following conditions:

- regular technical inspection of the boiler by the Service Center;
- the boiler connection to electrical mains complying with technical standards, voltage 230 V AC +10 - 15%, frequency 50 Hz, with earthing;
- the boiler is not subject to voltage fluctuations in the mains;
- the boiler is not subject to lightning strikes;
- the fuel supplied to the boiler corresponds to the characteristics which the boiler is designed for and are indicated in the appropriate places on the label and/or in the accompanying operating documents;
- air intake and flue gas venting systems comply with the manufacturer's requirements and applicable standards;
- during the maintenance, parts, and components subject to an abrasion must be replaced.

#### The water in the heating system and the DHW system must comply with the following requirements:









- average hardness (<math><20^{\circ}\text{fr}</math> - <math><200\text{ mg/l CaCO}\_3</math>);
- pH rate is between 7-8 pH;
- the physical and chemical content complies with the standards of the country where the appliance is installed.

#### Condition and shelf life of the product:

Storing in the manufacturer's package, in closed rooms with natural air circulation under standard conditions (non-aggressive and dust-free environment, temperature difference from  $-10^{\circ}\text{C}$  to  $+37^{\circ}\text{C}$ , air humidity up to 80%, without impacts and vibrations). Shelf life is up to 2 years. Product service life under the condition of complying with the rules of transportation, storage, installation, and operation is 10 years.

## User Manual

### General safety rules for usage

-  **ATTENTION!** Before switching on the boiler, the user must ensure that the warranty card has the stamp of the Service Center confirming the examination and the first start-up.
-  **ATTENTION!** To maintain the warranty, the start-up must be carried out by a Service Center approved by Federica Bugatti.
-  **ATTENTION!** The manufacturer's warranty is only applicable when this manual is strictly followed.
-  **ATTENTION!** The equipment may only be used for the purpose which is designed for heating the water to a temperature below boiling point at atmospheric pressure. Operation for any other purpose is not foreseen and is dangerous. The manufacturer accepts no responsibility for damage to people, animals, and material objects caused by improper usage.
-  **ATTENTION!** People (including children) with impaired physical, sensory, and mental abilities or inadequate skills and experience are not allowed to operate the boiler unless they have not been instructed in the use of the equipment and are accompanied by an observer who is in charge of their safety.
-  **ATTENTION!** Do not cover the vents of the room in which the appliance is installed to prevent the formation of toxic, explosive mixtures.
-  **ATTENTION!** In the case of smelling any gas in the room where the boiler is installed, follow these instructions:
  - Do not use electrical switches, telephones, or other devices that can generate electrical charges or sparks;
  - Immediately open all doors and windows to purge the room of contaminated air;
  - Switch off the gas valve;
  - Contact an expert who has sufficient knowledge to act in an emergency.
-  **ATTENTION!** Operation of the boiler connected to the mains requires compliance with the following basic rules:
  - Do not switch on the appliance with wet hands;
  - Do not pull the power cable;
  - Do not subjugate the equipment to the weather (rain, direct sunlight, etc.);
  - If the electrical cable is damaged, cut the power off and contact the Federica Bugatti Service Center.

### Disposal of the product

Disposal of the appliance is performed by authorized organizations for handling and recycling household appliances in accordance with applicable regulations. For an explanation of the procedure for disposing of your old equipment, please contact your local utility service or district administration.

### Precautions to take before initiating the boiler

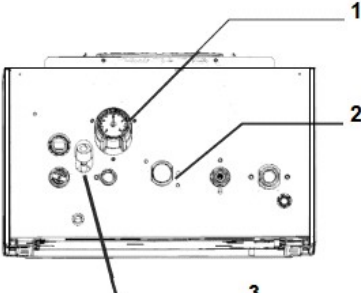





1- The pressure gauge of the heating circuit	
2 – Connection the gas mains	
3 – Valve for system pressurization	



- Ensure that the boiler is connected to gas mains 3.
- Ensure that the boiler is energized and the display shows only the following message **OFF**
- By using the pressure gauge 1 make sure that the system pressure in the cold state is between **0,7** and **1,5 bar** (optimal: **1 ÷ 1,5 bar**). If the pressure is less than **0,5 bar**, the boiler stops functioning. In such case, open the replenishing valve 2 until the value on the pressure gauge reaches **1 ÷ 1.5 bar**.

## Switching on the boiler and adjusting operation modes



The boiler mode can be adjusted between Winter (hot water + heating), Summer (hot water only), or heating only by pressing the button .

Pressing the button :

- once will switch the boiler to summer mode (DHW only). Only  indicator will be shown on display;
- twice will switch the boiler in winter mode (heating + DHW)   indicators will be shown on the display;
- every additional press on the  button will switch the boiler cyclically to the following modes:  «Off»,  «Summer», and  «Winter».

In winter mode   In winter mode, on demand of the room thermostat (if it is installed), the burner is activated and the heated heating medium starts to circulate through the heating system. In the event of simultaneous hot water and heating requests, the DHW request takes priority over the heating mode. As the DHW requests are short in duration, this does not usually affect the quality of heating the room.

## DHW temperature adjustment

- Setting the hot water temperature: the user sets the desired hot water temperature using the ,  buttons (the value is shown on the display under the indicator  during the adjustment). The adjusted temperature value is displayed for another 5 seconds after pressing the button for the last time and the display switches back to the regular status. With this particular type of boiler, it is recommended to adjust the hot water temperature so that it is not necessary to open the cold water tap on the standpipe or to open it slightly by adding cold water only a little. Do not adjust the hot water temperature to the maximum unnecessarily. Note that it may take a small amount of time to reach the adjusted temperature value due to the configuration of the system (length of pipes, etc.). The best assessment of temperature value can be made when filling the bathtub or using the shower.

## Features of the DHW, DCW, and heating circuit

**The cold water pressure at the boiler inlet must not exceed 6 bar, for optimal boiler operation, it must be higher than 1 bar.** A very low inlet pressure may not allow for proper pressurization of the heating system and reduce the hot water flow.

**(i)** In the event of high cold water pressure at the boiler inlet, it is necessary to install a device to reduce it. When installing such a device, it is necessary to follow the applicable standards and regulations for its installation, usage and safety, as well as the instructions of the device.

**The frequency of cleaning the plate heat exchanger depends on the hardness of the tap water.** If the water hardness is higher than 3.5 mg-eq/l, it is recommended to install a water-softening device at the boiler inlet. In addition, the presence of solid particles and impurities in the water (e.g. in the case of a new system) can impair the proper operation of the boiler. It is recommended that a filter should be installed to protect the hydraulic system.



**Ensure that the DHW and heating system pipes are not used as earthing connections.**

The efficiency, durability, and safety of the boiler are directly dependent on the quality of the water used and its purification.

Proper water purification enhances the protection of systems against corrosion (and therefore against breakdown, noise, leaks, etc.) and against scaling, which vastly reduces the efficiency of the heat exchanger (it is stated that 1 mm of limescale reduces the efficiency of the heating medium where it has formed by 18%).

It is recommended to use water as a heating medium in the heating system. The quality of water used in the heating and DHW system must comply with the following parameters:

- Hydrogen index PH 7-8,5;
- Total hardness not more than 3.5 mg-eq/L;
- Iron content not more than 0.3 mg/l.

- (i)** Flush the heating system thoroughly with water before connecting it to the boiler. The process will help to reduce (or eliminate) residual debris such as welding drips, mastic, dirt deposits of various origins, soot, rust and other build-up from the heating system and radiators. Otherwise, these particles can damage internal components of the boiler such as the circulation pump.
- **In the event of a very dirty or old system, special cleaning products** should be used for flushing in the quantities and proportions recommended by the manufacturer of such product.
  - If the water at the boiler inlet has a hardness higher than 3.5 mg-eq/l, it is necessary to install a water softening device to soften the water hardness.





### **Inadequate hot water productivity (DHW)**

- Check whether the DHW temperature is adjusted too low. If so, it must be adjusted (see "DHW temperature adjustment");
  - Have a qualified technician inspect the operation of the gas valve and adjust it.;
  - Have a qualified technician inspect and potentially clean the plate heat exchanger.
- (i)** Where tap water hardness values are too high, it is recommended to install filtration a system to reduce the hardness. This will prevent limescale deposits on the internal walls of the heat exchanger surface and, as a consequence, the need for regular cleaning, as well as prolonging the life of the heat exchanger.

### **Heating circuit temperature adjustment**

**Note:** If a low-temperature system kit or an external temperature control sensor is installed, please observe their instructions.

**Note:** Do not confuse the heating circuit temperature  described here with the room air temperature set on the room thermostat.

- **Adjusting the heating temperature:** Adjust the heating circuit temperature using buttons  and , (the temperature value is shown in the display under the  indicator during the adjustment). During adjustment, the radiator symbol flashes, and the adjusted value is shown on the LCD. The adjusted temperature value is displayed for another 5 seconds after pressing the button for the last time and the display switches back to its regular status. Typically, with the onset of cold weather and/or if the building is insufficiently isolated (or if you notice that the burner is active for a long time and the air temperature does not reach the value adjusted on the room thermostat), increase the temperature in the heating circuit. On the contrary, if you notice that the room temperature is significantly higher than the value adjusted on the thermostat due to thermal inertia, it is recommended to reduce the temperature in the heating circuit. **If an external temperature sensor is additionally installed, the temperature in the heating circuit changes automatically, and the assignments of the buttons   are different from those described above.** In such cases, observe the chapter "Heating circuit with connected outdoor air sensor heating function".

### **Operating principle of the heating circuit**



- The drainage from the heating system pressure relief valve (3 bar) must be connected to the sewage system. Failure to do so will result in flooding of the property in the event of the pressure relief valve triggering, for which the boiler manufacturer will not accept any responsibility.
- The boiler is designed for indoor heating systems with compulsory circulation.
- To ensure the long and efficient operation of the boiler and heating system, it is recommended to install the heating system from polymer or copper pipe.
- A mechanical filter must be installed on the return pipe of the heating system.
- It is preferable to use modern low-inertia radiators (steel panel, aluminium, etc.) as heating appliances.



## Function of the heating circuit connected with an outdoor air sensor

The boiler automation provides operation in the weather-dependent mode and has the opportunity to connect an external temperature sensor. It allows to operate the boiler with great comfort for the user, as well as to improve fuel economy during the operation of the equipment.



If an outdoor sensor is installed and the temperature measured by it is below + 50°C, the boiler automatically switches to the outdoor sensor operation. In such a mode, the coefficient heat dissipation

is regulated by parameter "P14" and the buttons  and  regulate the adjusted room temperature between 15°C and 25°C. The heating circuit temperature reference set point is determined by the coefficient of heat dissipation and the room temperature set point. The boiler operates according to the defined reference set point for heating.

**Note:** The estimated adjusted heating circuit temperature for the value in the weather-dependent operation mode never exceeds the maximum temperature range and never falls below the minimum temperature range of the central heating mode. The formula for calculating the slope factor:

$$T_i = [(T_{\text{Room}} - T_e) * (K_e / 10)] + T_{\text{Room}}$$

$T_i$ : reference of the heating kit calculated by the system;

$T_{\text{Room}}$ : preset room temperature; [15°C ÷ 25°C] set by using the buttons  and .

$T_e$ : outdoor temperature;

$K_e$ : the specified value of the coefficient heat dissipation coefficient by the parameter "P14" [5 ÷ 35].

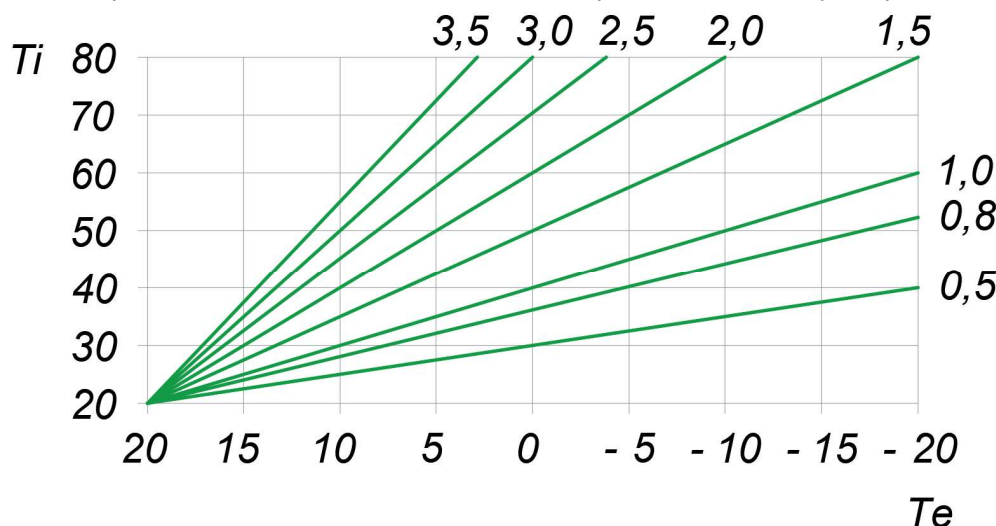

Values of temperature curves for  $T_{\text{Room}} = 20^\circ\text{C}$

## Precautionary functions

### Three-way valve lockout prevention function

After 24 hours of inactivity of the 3-way valve, the 3-way valve changes position for 10 seconds to prevent blockage. If the request occurs during the anti-blocking time, the anti-blocking is terminated. The function is also active in a lockout or standby state.

### Pump jam prevention function

After 24 hours of inactivity, the pump is switched on for 25 seconds to prevent blockage. If the request occurs during the anti-blocking time, the function timer starts counting again. The function is also active in a lockout or standby state.

### Anti-freeze function

If the water temperature measured by the heating circuit temperature sensor is beneath the bottom threshold of the frost prevention function for the heating or DHW circuit, the burner switches on. Once the flame is detected, the modulation level is set to the minimum.

The frost protection function is active in "Summer" or "Off" mode. In "Winter" mode, when there is no heat demand on the room thermostat, it activates. Only the pump is energized in the lockout state.

### Automatic boiler shutdown function

The boiler stops for 15 seconds if it is switched on continuously for 24 hours. The boiler returns to the selected operating mode after 15 seconds.

### Filling and adjusting the heating circuit pressure

After making all hydraulic connections to the system, proceed to fill the system. This operation must be carried out carefully, observing the following steps:



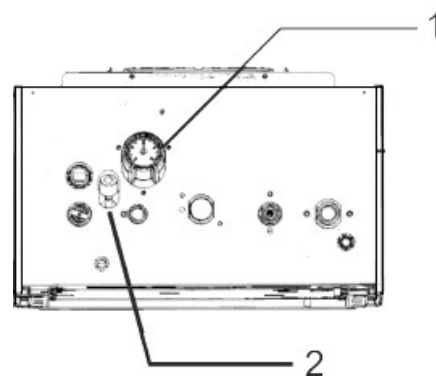













- Turn on the air bleeding valves on all radiators in the heating system;
- Check whether the plug of the automatic air bleeding valve integrated into the circulation pump is unscrewed. If not, unscrew it and leave it on.;
- If it is necessary to fill the system with antifreeze solution, after operating, hermetically turn off the connection or valve used to add antifreeze to the heating system to normalize the pressure in the system;
- Gradually turn on the replenishing valve 2;
- Check whether the automatic air bleeding valves installed in the system for proper operation;
- Turn off the radiator bleed valves as soon as the water starts to flow out of the radiators;
- Ensure that the arrow on pressure gauge 1 shows system pressure **1.0 bar (maximum 1.5 bar)**;
- Turn off the replenishing valve 2 and turn on air bleeding valves on all radiators in the heating system once again;
- Repeat the operation to bleed and pressurize the heating system until all the air is vented from the system.



### Button assignments, representation of the indicators on the display

				Indication of the temperature and possible malfunctions.
				Turn off.
	Mode selection: <b>ON/OFF/ SUMMER/ WINTER</b>			DHW operation indication.
	Error reset button.			Heating circuit operation indication.
	Increasing the hot water preparation temperature.			Not in use.
	Decreasing the hot water preparation temperature.			Not in use.
	Increasing the heating circuit temperature.			Flame presence indication.
	Decreasing the heating circuit temperature.			Error reset indication.

**Description of the indicators, which display the status of the boiler**

Status of the boiler	Indication on the display							Display backlight	
	Numbers, letters		Indications						
Switched off	OFF		-				-		
"SUMMER" mode hot water demand expectation	55°	The present hot water temperature is displayed.		Turns on.			-		
"SUMMER" mode hot water preparation.	35-60°	The present heated water temperature is displayed.		Blinks		Turns on.		-	
"SUMMER" mode hot water preparation temperature adjustment.	35-60°	The adjusted hot water temperature is displayed.		Blinks.			Goes off 60 seconds after operations are performed.		
"SUMMER" mode heating circuit temperature adjustment.	-		-				-		
"WINTER" mode standby.	35-80°	The present heating circuit temperature is displayed.		Turns on.		Blinks, on demand.		-	
"WINTER" mode hot water preparation demand.	35-60°	The present hot water temperature is displayed.		Blinks.		Turns on.		Turns on.	-
"WINTER" mode heating demand.	35-80°	The present heating circuit temperature is displayed.		Turns on.		Blinks		Comes on.	-
"WINTER" mode hot water preparation temperature adjustment.	35-60°	The adjusted hot water temperature is displayed.		Blinks.		Turns on demand		Goes off 60 seconds after operations are performed.	
"WINTER" mode heating circuit temperature adjustment.	35-80°	The adjusted heating circuit temperature is displayed.		Blinks.		Turns on demand		Goes off 60 seconds after operations are performed.	

## Draining the system

If the system needs to be drained, follow the instructions below:

- Cut off the power;
- Switch off the gas valve;
- Attach the rubber tube to the drain tap **1**;
- Place the other side of the rubber tubing, either in the sewer or in a vessel;
- Turn on the tap by rotating the hex gasket **2** counterclockwise with an adequate wrench;

**Note:** The system may only be completely emptied by draining from the lowest part of the system;

- Upon completion of operations, turn off the drain tap by rotating the hex gasket **2** clockwise.

In cases where the room temperature is expected to fall below 0°C, a qualified technician should be contacted to perform the following operations:

- Drain the system thoroughly. Note that if the system has already been filled with antifreeze and operations have been carried out to restore the pressure in the heating system (due to possible pressure drop), the concentration of antifreeze may diminish. Such circumstances do not guarantee freeze protection. **The manufacturer does not advise filling the system with antifreeze. Doing so may invalidate the appliance warranty. Please consult the manufacturer for antifreeze usage.**
- It is mandatory that the appliance be checked to ensure that it is completely free of water.
- Completely drain the DHW and the heating system, including the DHW circuit and plate heat exchanger.
- Since it is difficult to completely drain the water from all boiler components, it is recommended to disconnect the boiler from communications and store it separately in a heated room to avoid freezing of remaining water.

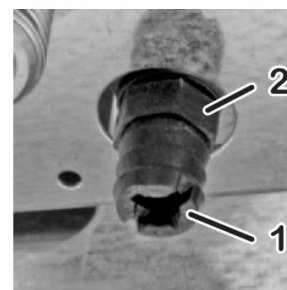
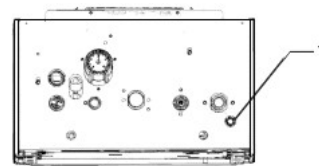

## Prolonged inactive state of the boiler and “Anti-freeze” function

Leaving the boiler in **OFF** mode during its inactivity provides freeze protection by the functions integrated into the motherboard, which command the heating of the relevant components when the temperature drops below the value adjusted by the manufacturer as the anti-freeze threshold. The anti-freeze function is performed by switching on the burner and the pump. In case of a power failure and its subsequent recovery, the boiler will check the temperature utilizing sensors and in case of detection of freezing, thanks to a special automatic control process, the boiler will indicate the error - **E 25**. For further information, see the relevant error description in the section “Faults in boiler operation and how to eliminate them”.

**Note:** The boiler is provided with a system that protects the main components against rare cases of lockout due to the boiler being idle (not used) in the presence of water and scale. The lockout protection system cannot operate in case of power failure. Furthermore, the boiler in standby mode periodically operates the main components. It occurs even in the case the boiler is in an error state (the display

shows **RESET**), but only if the system pressure is within the operating range.



Before switching on the boiler, after a long period of non-use, have the pump checked by a technician to ensure that it is not blocked due to prolonged inactivity: unscrew the blind plug in the centre of the pump's body and, having gained access to the rotor, rotate it with a screwdriver or any other appropriate tool).

To activate such functions, follow the instructions below:

- the boiler must be plugged to the gas and electric mains and the gas valve must be switched on;
- the boiler must be switched to the mode **OFF**;
- the pressure in the heating circuit should be **in the optimum range of 1.0 bar to 1.5 bar** (unheated heating medium), **a minimum of 0.7 bar**.

If the gas supply is absent or for any other reason the boiler enters an error state (the display will show

**RESET**

), the burner will not be able to ignite. In such a circumstance, the anti-freeze function will only be performed by activating the pump.

**(i)** **Attention!** The "Anti-freeze" function does not protect the sanitary and heating circuit outside the boiler. Hence, we recommend draining the DHW and HTW systems (pipes, standpipes) that may be at risk of freezing.

**(i)** In case of freezing danger at certain external points of the heating system, it is recommended to use a specific antifreeze, usually based on propylene glycol, following the instructions of its manufacturer. Pay attention to the correct concentration of antifreeze in the water, adding an incorrect amount of antifreeze to the water may deform the o-rings and cause noises or water leakage from the boiler or the system. The manufacturer accepts no responsibility for such damage.

If antifreeze is used in the heating system, it is necessary to mechanically limit the heat output of the boiler by 20 -25% of the nominal value, and additionally check the sufficiency of the boiler expansion tank capacity. Failure to fulfil these requirements may result in damage to the internal components of the boiler, which will not be accepted for warranty replacement.

**A qualified technician should inform the user about the type of antifreeze injected into the system and instruct on its purpose, properties and specifics of use. The manufacturer does not recommend filling the system with antifreeze. This may invalidate the warranty for the appliance. Consult the manufacturer for the application of antifreeze.**

### **Faults in boiler operation and how to eliminate them**

If the boiler has malfunctioned, it automatically shuts down and the error code is shown on the display

**888**<sup>°C</sup>. In case of blockage, the **RESET** indicator is shown concurrently on the display. A reset action has to be taken for lock-out type failures. The reset action is performed by pressing the  button.

### **Possible malfunctions of the boiler**





**Do not perform by yourself repair operations that are the competence of specialized personnel, as well as actions that are not specified in the "User Manual" section. The accessories used for the connection and operation of the boiler must be original. The manufacturer is not liable for improper, inappropriate, and erroneous usage of the boiler or usage of non-original accessories and spare parts.**

### **Absence of flame at the burner**

- If a room thermostat (programmable or equivalent type) is installed in the heated room, confirm whether it is demanding the room to be heated at that moment;
- Make sure that the boiler is energized and is not in the **088**, but in the **F III** "Winter" mode.
- The relevant **RESET** icon must be visualized on the display (see details in the section "Description of the indicators, which display the status of the boiler");
- Check the pressure in the system. The pressure gauge should indicate a value between 0.7 and 1.5 bar of unheated heating medium or at least 0.5 bar.

**Error codes appearing on the display**

<b>Error code</b>	<b>Description</b>	<b>Type of error</b>	<b>Actions to take</b>
<b>E 01</b>	When gas does not flow into the boiler, or ignition fails for any reason, the motherboard will display such an error. An error code may occur in both cases. Contact an authorized Federica Bugatti Service Center.	Ignition failure.	Press the reset button 
<b>E 02</b>	If the water output temperature in the heating circuit exceeds 100 °C, the safety thermostat is triggered, which for safety purposes shuts down the boiler and an error code is indicated on the display. The boiler reboots and continues operating, in case of an overheating. If this error occurs frequently, contact an authorized Federica Bugatti Service Center.	Safety thermostat triggered (water temperature at the heating system outlet exceeds the allowed temperature limit)	Press the reset button 
<b>E 03</b>	The error code occurs in the following cases: air pressure switch malfunction, chimney clogging, and fan malfunction. There may be problems in the chimney system. Switch off the boiler and contact an authorized Federica Bugatti Service Center.	The air pressure switch (combustion products pressure switch) has triggered	Once the malfunction is eliminated, the boiler re-operates automatically
<b>E 04</b>	The error code occurs when the water pressure in the heating system drops below 0.5 bar. The water pressure drops if leakage is present in the heating system. The system should therefore be inspected for leaks. Check the pressure on the pressure gauge. If the water pressure is too low (less than 1 bar), switch off the boiler, check the air bleed appliances, and switch the replenishing valve on. Fill the water until the pressure gauge indicates water pressure at 1.5 bar. When the water filling is complete, tightly switch off the replenishing valve.	Low water pressure in the heating system	Once the malfunction is eliminated, the boiler re-operates automatically
<b>E 05</b>	The error code occurs if the NTC surface temperature sensor in the heating circuit malfunctioning. Contact an authorized Federica Bugatti Service Center.	The NTC surface temperature sensor in the heating system malfunctioned.	Once the malfunction is eliminated, the boiler re-operates automatically
<b>E 06</b>	The error code occurs if the DHW temperature sensor malfunctioning. Contact an authorized Federica Bugatti Service Center.	DHW temperature sensor malfunctioned.	Warning, boiler continues to operate
<b>E 07</b>	The NTC surface sensor temperature in the heating circuit outlet line exceeds 93°C. When the temperature drops to 80°C, regular operation is initiated automatically. If such an error occurs frequently, contact an authorized Service Center.	The temperature in the heating system supply line exceeds the allowable value limit	Once the malfunction is eliminated, the boiler re-operates automatically

<b>E 25</b>	<p>When the NTC Sensor of the heating system measures the temperature below 1°C for 10 seconds, the motherboard displays such an error and thus the main heat exchanger is detected as "frozen". The burner stops operating. The pump is not activated. When the temperature rises to + 3°C, regular operation starts automatically.</p> <ul style="list-style-type: none"> <li>- Drain the water from the boiler</li> <li>- Cut the power off</li> <li>- Turn off the gas valve</li> <li>- Wait until the temperature in the main heat exchanger reaches +3 °C. Then refill the boiler with water again and try to start it up.</li> <li>- If the error appears again, contact the Federica Bugatti Service Center.</li> </ul>	Freezing	Once the malfunction is eliminated, the boiler re-operates automatically
<b>E 41</b>	<p>If a spurious flame is detected for at least 10 seconds even if the burner is not switched on. If the flame indicator goes off for at least 1 second, regular operation continues. Contact an authorized Federica Bugatti Service Center.</p>	"Spurious" (parasite) flame	Once the malfunction is eliminated, the boiler re-operates automatically
<b>E 42</b>	<p>If the flame detection signal is out of range for 15 seconds, this error is issued. If the flame detection signal is within the normal range for 2 seconds, normal operation is resumed. Contact an authorized Federica Bugatti Service Center.</p>	Ionization component malfunction	Once the malfunction is eliminated, the boiler re-operates automatically
<b>E 44</b>	<p>Error related to the gas valve actuator and feedback verification circuitry. The RESET button can be pressed to resolve the malfunction. If the error reappears, contact the Federica Bugatti Service Center.</p>	Gas valve feedback	<p>Press the reset button</p> 
<b>E 76</b>	<p>The error code occurs in the event of insufficient voltage presence on the gas valve winding. Contact an authorized Federica Bugatti Service Center.</p>	Gas valve modulation error	Once the malfunction is eliminated, the boiler re-operates automatically

## Technician Manual

### Internal components of the boiler

Federica Bugatti Varme 12/18/24

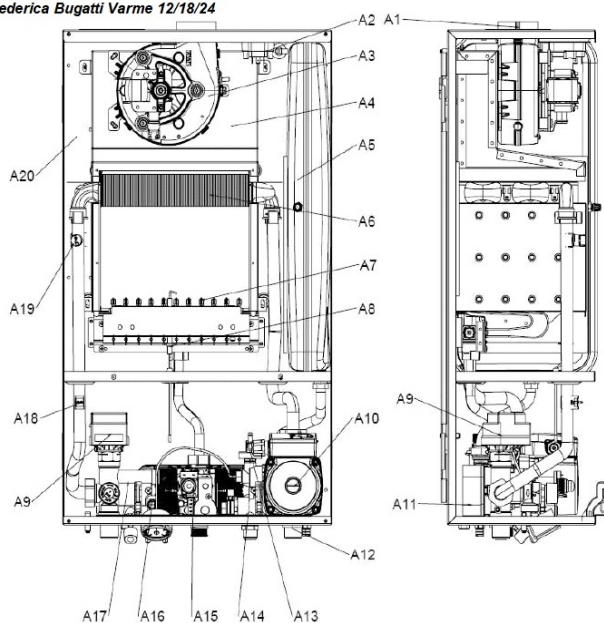

- A1. Chimney connection;
- A2. Air pressure switch;
- A3. Fan motor;
- A4. Fanhood;
- A5. Expansion vessel;
- A6. Main heat exchanger;
- A7. Burner;
- A8. Ignition and ionization electrode;
- A9. 3-way motorized valve;
- A10. Circulation pump;
- A11. Plated heat exchanger;
- A12. Drain tap;
- A13. Low pressure switch;
- A14. Hall effect sensor;
- A15. Gas valve;
- A16. DHW temperature sensor;
- A17. 3 bar pressure relief valve;
- A18. NTC heating circuit temperature sensor;
- A19. Safety thermostat (outlet);
- A20. U body.

Federica Bugatti Varme 28/32

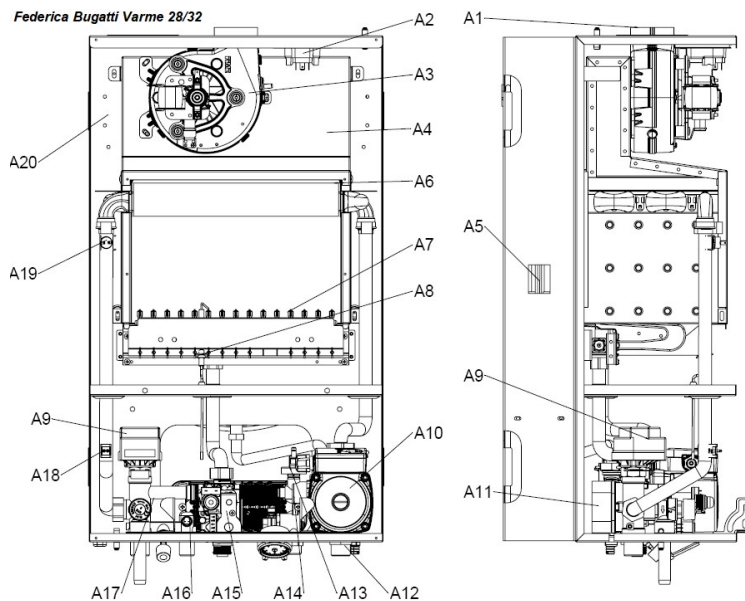



## Hydraulic diagram

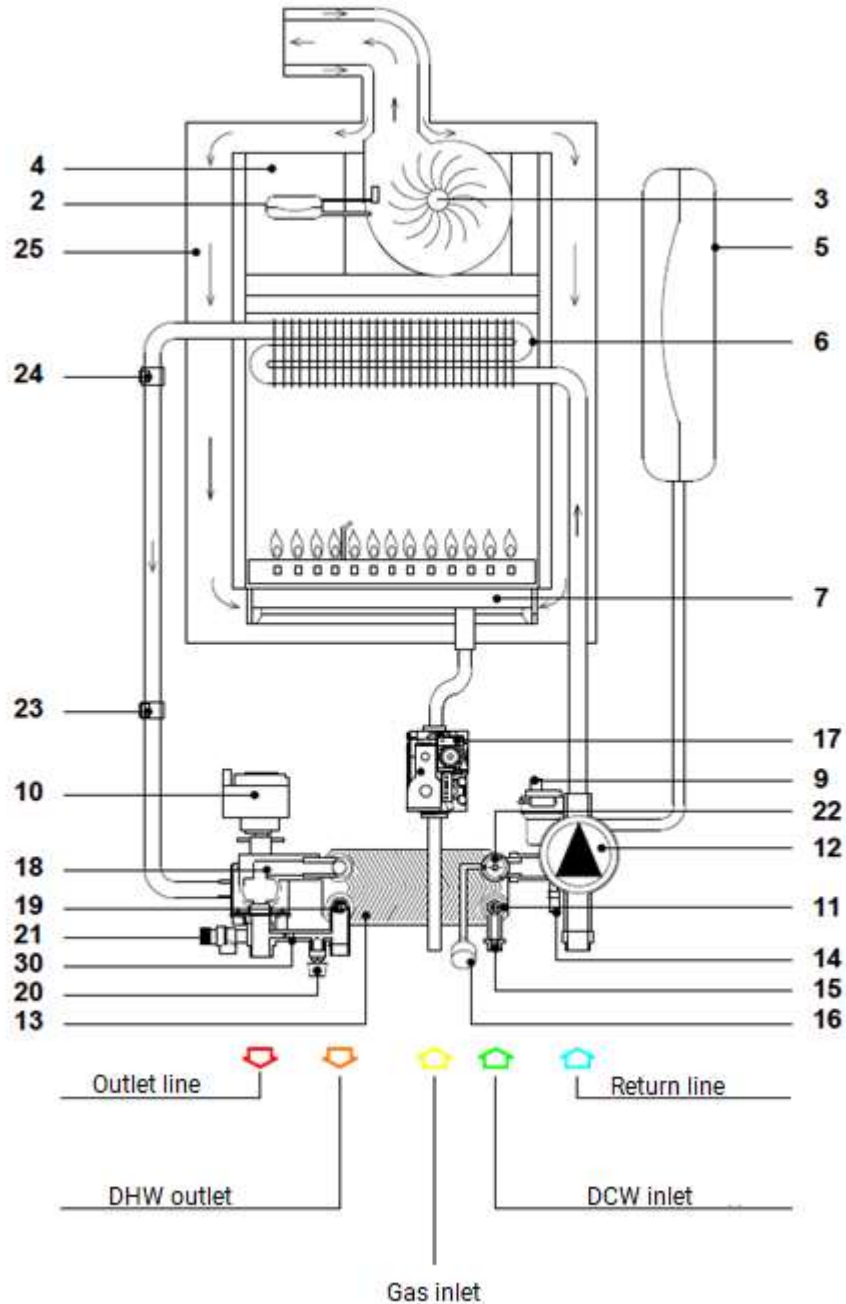

- 2. Air pressure switch;
- 3. Fan motor;
- 4. Fanhood;
- 5. Expansion vessel;
- 6. Main heat exchanger;
- 7. Burner;
- 9. Automatic air bleeding valve;
- 10. 3-way motorized valve;
- 11. DHW flow sensor;
- 12. Circulation pump;
- 13. Plated heat exchanger;
- 14. Drain tap;

- 15. Cold water filter;
- 16. Pressure gauge;
- 17. Gas valve;
- 18. By-pass (integrated on the 3-way motorized valve);
- 19. DHW temperature sensor;
- 20. Replenishing valve;
- 21. 3 bar pressure relief valve;
- 22. Low-pressure sensor;
- 23. NTC heating circuit temperature sensor;
- 24. Safety thermostat (outlet);
- 25. Combustion chamber.

## Placement of the boiler

For the proper installation of the boiler it is necessary to take into account that:

- it must not be installed over a stove or such cooking appliances;
- it must not be installed in living rooms;
- it is forbidden to store flammable products in the room where the boiler is installed;
- If the wall is heat sensitive (e.g. wooden wall), it must be protected with appropriate thermal insulation.

## Minimum distances

To be able to gain access to the inside of the boiler for routine maintenance, the minimum distances to walls and objects on the sides of the boiler of at least 100 mm and under the boiler of at least 150 mm must be left during installation.

## Requirements for the air intake of the boiler

For a proper and safe ignition and combustion of the gas-air mixture in the combustion chamber, the air intake to the combustion chamber must not contain chemical impurities (contaminants) such as: fluorine, chlorine, sulfur, ammonia, alkalis, and other similar chemical substances. In case of installation of the boiler in a space with insignificant content of aggressive chemicals in the air (e.g. hairdressers, laundries), we recommend installing boilers type C, with air intake for combustion from the atmosphere outside the heated room.

For the given type of boilers, different configurations of flue gas venting and air intake are possible: C12, C12x, C22, C22x, C32, C32x, C42, C42x, C52, C52x, C82, C82x, C92, C92x

## Positioning and mounting the boiler

**Not:** A special disposable paper template is available as an option to facilitate the positioning of the fixing points. If the disposable paper template and/or the original connection kit is not used, the position of the hydraulic connections of the boiler can be found in the paragraph "Overall connection measurements". To mount the boiler, choose the location so that there is enough space from the side and bottom surfaces of the boiler for service work: at least 100 mm from the side surfaces and at least 150 mm from the bottom of the boiler.

- In case of using a paper template, place it against the wall utilizing the same fixings and holes designed for the boiler.
- Place the heating, cold water, hot water, gas pipes, and electrical connections so that they pass through the holes in the metal template or in compliance with the measurements indicated in the figure or the paragraph "Overall connection measurements". The upper edge of the boiler is used as a starting point for the measurements according to the paragraph "Types of flue gas ventilation and air intake systems".
- Remove the plastic plugs from the boiler's hydraulic fittings.
- Afterwards, assemble the hydraulic connections, gas connections, power supply and electrical components, flue gas ventilation, and air intake system connections, following the instructions in the relevant paragraphs.
- The boiler connections are designed for making connections using properly proportioned gaskets made of materials that guarantee a solid fixation without excessive tightening. The usage of hemp, Teflon, or such materials is not recommended for sealing. The fixing/hanging points of the boiler must be selected depending on the fixing elements used or possibly already existing (open hooks, screw dowels, etc.).

## Gas connection



**It is a MUST to use a flat gasket, whose dimensions and material of construction are regulated for sealing the connection between the boiler and the gas mains pipe. DO NOT use tow, Teflon tape, or similar material as sealing material. Due to the nature of the connection, the use of the above materials will not form the required seal and will result in gas leakage!**



**The boiler is designed to operate on natural gas G20 (methane). The gas type can be changed to G30/G31 LPG, but always only by an authorized technician and using original parts.**

**When operating on LPG it is obligatory to use a pressure reducer, without it the gas valve of the boiler can be damaged. The gas pressure at the boiler inlet must be in accord with the data in the table "Technical data".**

The gas connection of the boiler, as well as the whole process of the boiler installation, must be performed by a qualified technician trained to work with this appliance, in compliance with all prescribed rules and regulations applicable at the time of installation of such appliance.

**Faults in the gas connection of the boiler can cause fire, explosions, and other serious damage to people, pets, and other property, for which the manufacturer is not responsible.**



**Before connecting the boiler to the gas mains it is necessary to check:**

- Clean all gas pipes to avoid the presence of impurities that could adversely affect the operation of the boiler;
- Correspondence of the gas supply pipelines in accordance with applicable norms and regulations;
- The gas pipes and gas system connections for leak tightness;
- The inlet pipe of the gas system must have a cross-section/diameter greater than or equal to the diameter/cross-section of the boiler's gas connection socket;
- The type of gas, which is used must be in accord with the indicated information on the boiler label. If this is not the case, the technician must convert the boiler to the correct gas type;
- The gas shut-off valve must be installed in front of the boiler;
- The plastic plug has been removed from the boiler gas connection socket.
- Bleed the air from the gas supply line.

## Power connection



The connector for the room thermostat is low-current with low voltage (SELV): connect it to the appropriate terminals of the thermostat or digital thermostat. **Do not apply any voltage to them under any circumstances!**



All low-current connections (e.g. thermostats and programmable thermostats) must be routed separately from the power cables to avoid interference due to the resulting electromagnetic fields around the power cable. It is recommended to route such types of cables in separate cable ducts.



When connecting the wires coming out of the boiler, make sure that they are not too tight and that they allow the opening of the control panel.

The boiler must be connected to the mains with a voltage of 220÷240 V and a frequency of 50 Hz. The value of voltage in the mains may differ from the declared (230 V) in the range of -10% .... +10%. Otherwise, errors or malfunctions in boiler operation may occur. It is essential to observe the polarity of phases L-N when connecting the boiler to the mains (L = brown wire, neutral N = blue wire) and earthing (yellow-green cable).



The boiler must be connected via a double-pole switch that complies with all applicable standards.

If the supplied electrical cable must be replaced or its length is inadequate, use commercially available electrical cable type: H05VVF or H05-VVH2-F with a core cross-section of at least 0.75 mm<sup>2</sup>. **Connection to an earthing is mandatory in accordance with applicable regulations.**

If it is necessary to completely change the cable, perform the replacement in the following sequence: remove the control panel cover, unlock the cable clamping device, and disconnect the cables. Replace the new cable in the reverse order. When connecting the cable to the boiler, the following must be observed:

- The earthing conductor must be 2 cm longer than the other two conductors (phase and neutral);
- Attach the wire using the appropriate clamping devices.



The electrical safety of the appliance is considered sufficient only if it is earthed to an effective earthing circuit that complies with applicable electrical safety standards and regulations.

A qualified technician must check that the electrical circuit corresponds to the maximum power consumption of the boiler indicated on the label, ensuring in particular that the cross-section of the circuit wires corresponds to the power consumption of the boiler.



Federica Bugatti accepts no responsibility for harm to persons, animals or property due to failure to properly earthing the boiler and to comply with applicable regulations.

### Electrical circuit diagram

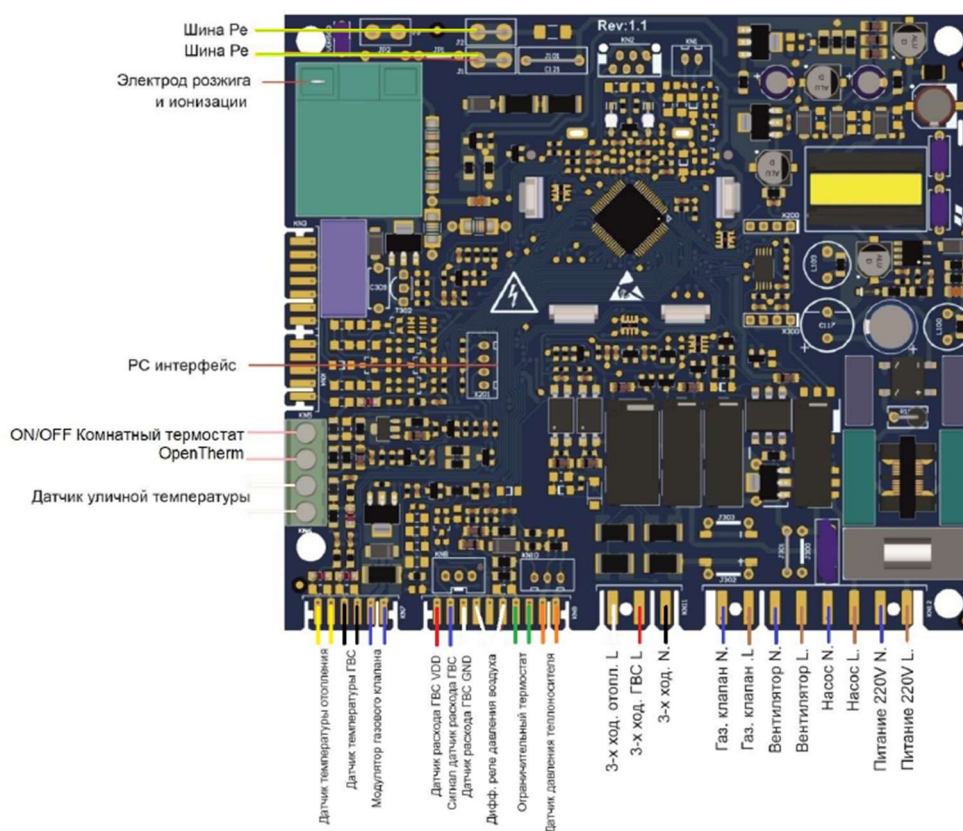

*ON/OFF Room thermostat / OpenTherm – pink/pink;*

*Outdoor temperature sensor – white/white;*

*NTC heating circuit temperature sensor – yellow/yellow;*

*DHW temperature sensor – black/black;*

*Gas valve regulator – blue/blue;*

*VDD DHW flow sensor - red/DHW signal – blue/GND DHW flow – white;*

*Differential air pressure switch (pressurestat) – white/white;*

*Limit thermostat – green/green;*

*Heating medium pressure sensor – orange/orange;*

*L 3-way motorized valve heating part – white/ L 3-way motorized valve DHW part – red/ N 3-way motorized valve – black ;*

*N gas valve - blue/ L gas valve – brown;*

*N fan – blue/ L fan – brown;*

*220V N power - blue/220V L power – brown;*

*Earthing bus – yellow-green*

## Chimney connections, general recommendations

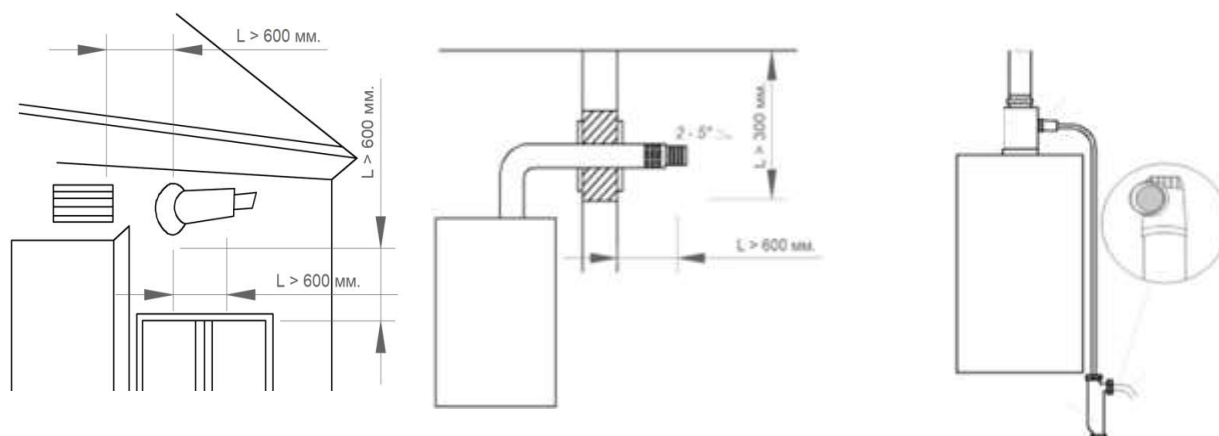

- To rooms at which the boiler with closed combustion chamber is located must be installed general exchange ventilation, which provides the exchange rate of air at least 3 times in 1 hour.
- To ensure the functionality and efficiency of the appliance, must be provided a slope for the air intake and flue gas ventilation, on horizontal sections by 2%-5% (see Fig.).
- On vertical sections adequate devices must be used for the collection and drainage of condensate.
- Air intake and flue gas venting systems must be protected against atmospheric substances adhering to them.
- The flue gas pipe must be connected to the chimney perpendicular to the axis of the chimney and must not extend into the chimney.
- Strictly comply with the applicable regulations and laws.
- Take into account the min. and max. distances described in the paragraph "Types of flue gas ventilation and air intake systems".

Efficient and safe operation of the boiler is guaranteed only if the original flue gas ventilation and air intake pipes designed for boilers with closed combustion chambers are used.

## Diaphragm for abbreviated systems

Depending on the length of the flue gas vent, it may be necessary to install a special throttling diaphragm on the boiler flue gas venting pipe. The required component is included in the boiler. Instructions for the usage of the diaphragm (and for the corresponding diameter, if a special diaphragm is ordered) are given in the paragraph "Types of flue gas ventilation and air intake systems", depending on the type and length of the system.

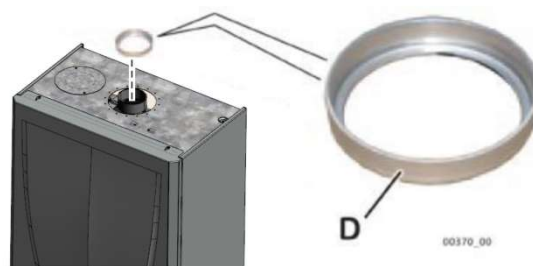

- (i) Observe the tables, and calculate the equivalent linear length, taking into account each additional elbow (excluding those already shown in the figure). If necessary, install the diaphragm D as indicated in the figure.
- (i) Observe the statutory regulations while assembling the bend pipes.

## Types of the flue gas ventilation and air intake systems

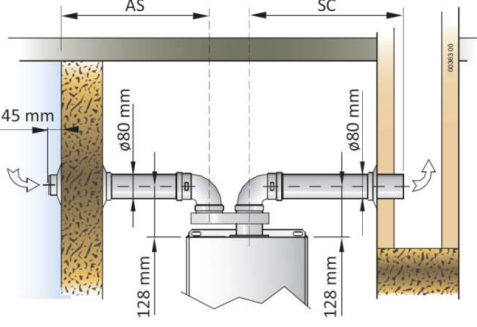
Sample of a partitioned system C82	Model	Partitioned system Ø80 mm (with a divider on coaxial connection)			
	<b>Federica Bugatti Varme 24B/32B</b>	AS+SC min. ÷ maks. (m)	SC maks. (m)	Diaphragm	
		2 ÷ 16	14	Length AS+SC (m)	Ø mm
Do not consider AS for systems of type B22 (room air intake)					
AS = air intake SC = flue gas exhaust		for a 90° Ø80 elbow, the equivalent length is 0,5m for a 45° Ø80 elbow, the equivalent length is 0,25m			
<b>Note: C12 and C32 type systems are also possible with a partitioned system</b>					

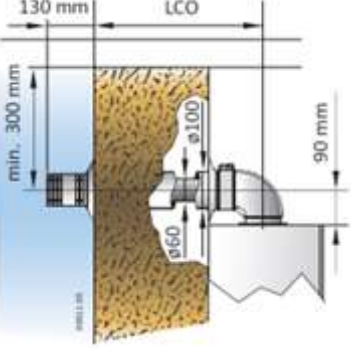
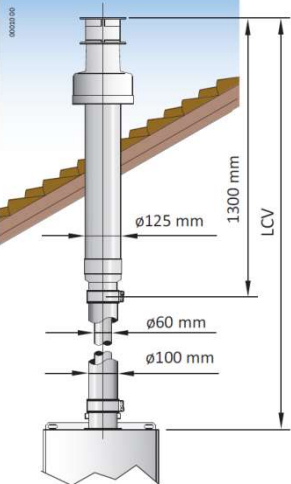
Sample of a horizontal coaxial system C12	Model	Coaxial system Ø60/100 mm			
	<b>Federica Bugatti Varme 24B/32B</b>	LCO min. ÷ maks. (m)	LCV min. ÷ maks. (m)	Diaphragm	
		0.8 ÷ 4	0.8 ÷ 5	LCO or LCV length (m)	Ø mm
(F): The diaphragm is supplied with the boiler					
for a 90° Ø60/100 elbow, the equivalent length is 1,0 m		for a 45° Ø60/100 elbow, the equivalent length is 0,5 m			
Sample of a vertical coaxial system C32	Model	Coaxial system Ø60/100 mm			
	<b>Federica Bugatti Varme 24B/32B</b>	LCO min. ÷ maks. (m)	LCV min. ÷ maks. (m)	Diaphragm	
		0.8 ÷ 4	0.8 ÷ 5	LCO or LCV length (m)	Ø mm
(F): The diaphragm is supplied with the boiler					
for a 90° Ø60/100 elbow, the equivalent length is 1,0 m		for a 45° Ø60/100 elbow, the equivalent length is 0,5 m			

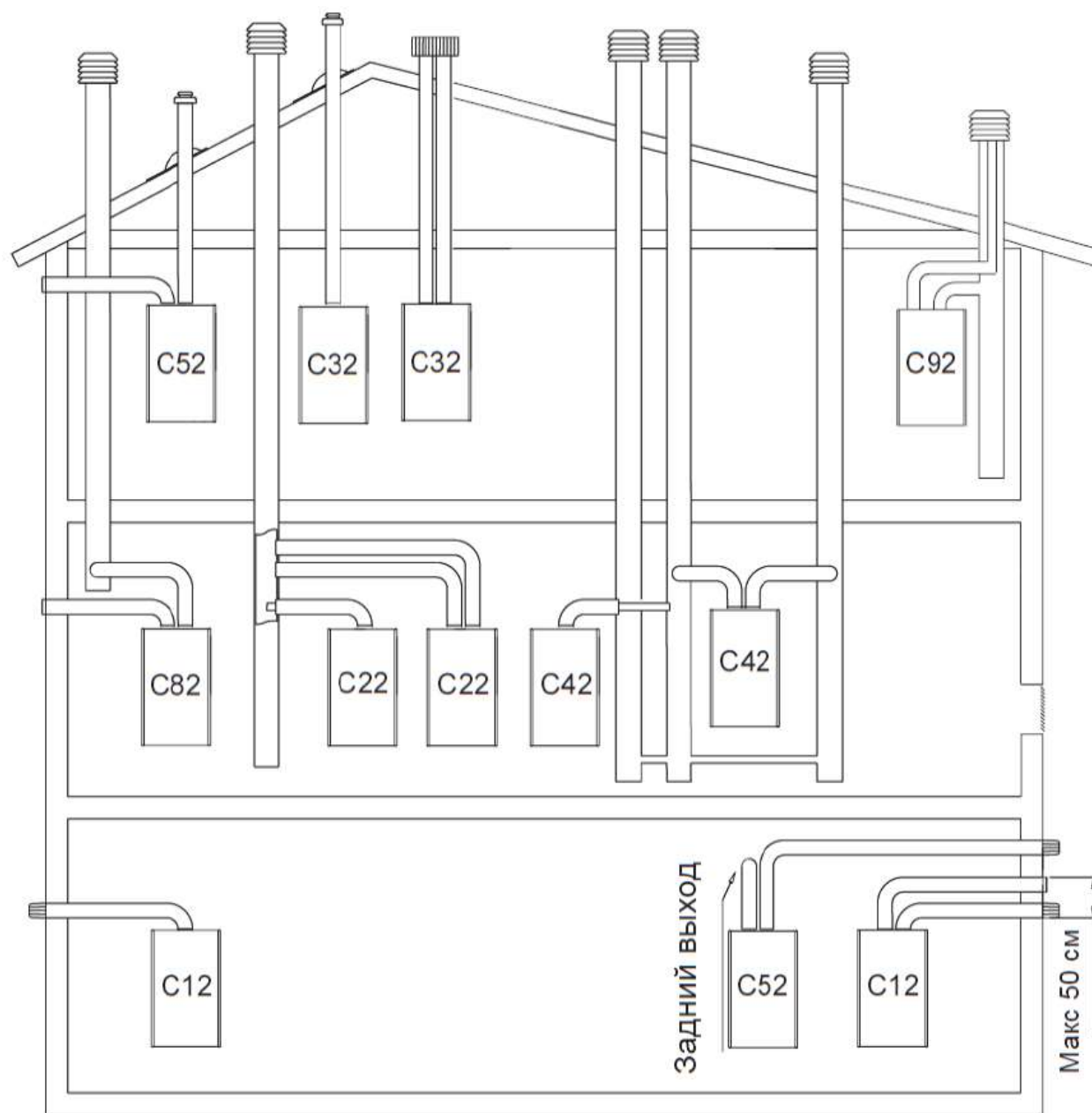
**Various chimney configurations**

**C12-C12x** Flue gas outlet via coaxial flue/air ducts. The pipes and ducts can be separate or coaxial. If separate flue/ducts are used, their outlets must be close enough to be in the same wind conditions.

**C22** Coaxial outlet to collective flue/air duct (air intake and flue gas outlet to the same coaxial flue/air duct) **C32-C32x** Coaxial output on the roof. Outputs like the ones in the C12.

**C42-C42x** Flue gas venting through a collective chimney and air intake from a collective duct that is subject to the same wind conditions.

**C52-C52x** The flue gas outlet and air intake are separated and exit from the wall or to the roof, but in either case in areas where the pressure is different.

**C82-C82x** Flue gas outlet into a separate or collective chimney and air intake individually through the wall.

**C92-C92x** Flue gas outlet to the roof (as in C 32), while the air intake from the present individual chimney.

## Overall connection measurements

### Federica Bugatti Varme 12/18/24

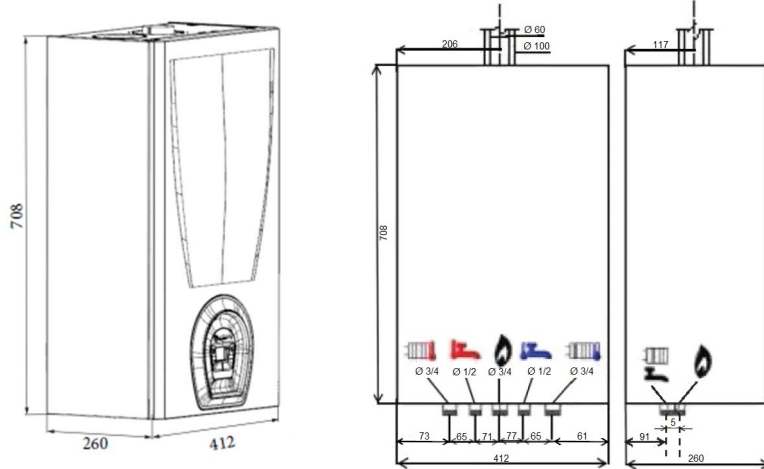

### View from the top

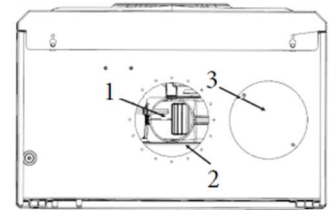

- 1-Flue gas vent
- 2-Air intake
- 3-Additional air intake

### Federica Bugatti Varme 28/32

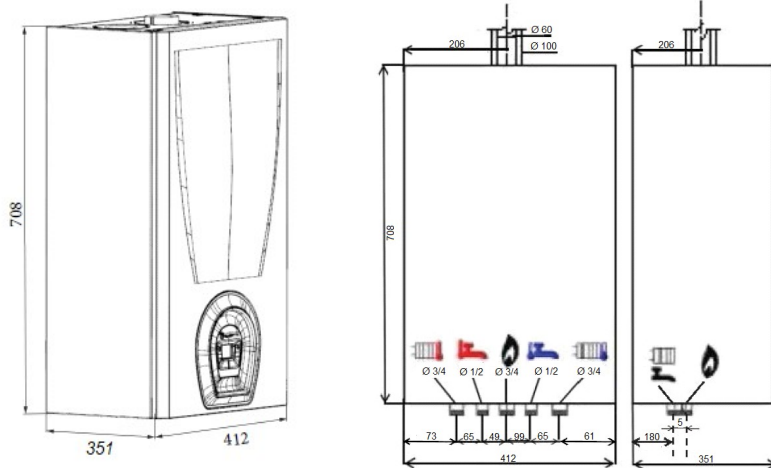

### View from the bottom

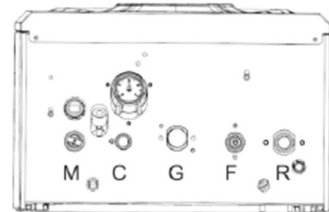

- M-Outlet line (3/4")
- C-Hot water outlet (1/2")
- G-Gas connection (3/4")
- F-Cold water inlet (1/2")
- R-Return line (3/4")

## Diagram for determining the remaining pressure head inside of the pump, and pump adjustments

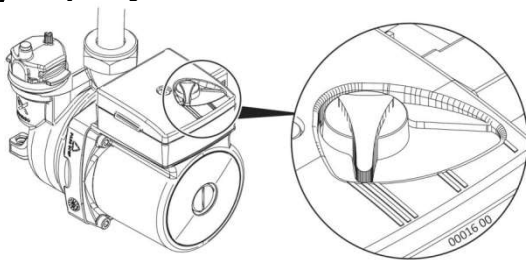

III = maximum speed (factory set);  
 II = average speed;  
 I = minimum speed (used if necessary; perform a test for the heating system, checking for problems due to overheating of the heating medium).

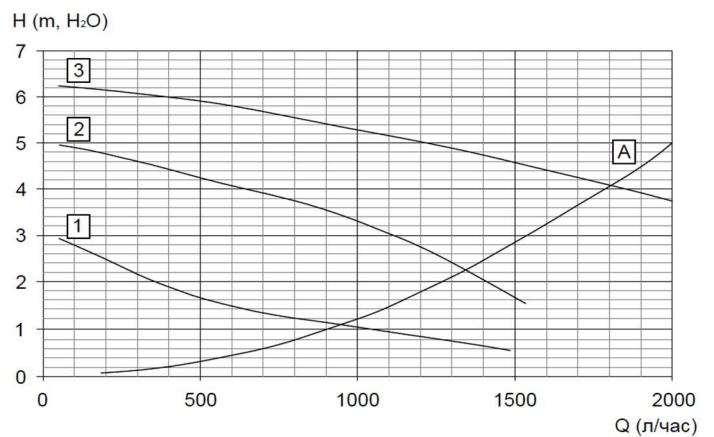

The circulation pump is equipped with a speed switch, which makes it possible to reduce potential noise caused by the high speed of liquid movement in the heating system.

- \_\_\_\_\_ 1 Speed
- \_\_\_\_\_ 2 Speed
- \_\_\_\_\_ 3 Speed
- \_\_\_\_\_ A Hydraulic resistance of the boiler







## Operations to be performed before commissioning the boiler

Operations to perform during the first start-up of the boiler consist in checking the correctness of the installation for the whole system and its functioning and, if necessary, in its regulation:

- Check whether the data stated on the boiler's label corresponds to the data of the supply network (electricity, water and gas);
- Check for gas leaks at the boiler connection points;
- Check the correct implementation and efficiency of all connections to the boiler (water, gas, heating system and electricity);
- Check the presence, correct size, and functioning of ventilation openings, which must, in turn, comply with applicable local legislation;
- Check whether the chimney complies with applicable local legislation, is in good condition, and working efficiently;
- Check the combustion air intake ducts for correctness and compliance with applicable regulations;
- Check the ventilation conditions of the boiler itself, in case it is installed inside of a wardrobe.;
- Check gas pressure and flow rate at the boiler inlet (see "**Gas pressure inlet check, adjustment of max. and min. gas pressure at the burner**");
- Check the pressure at the maximum and minimum output and adjust the gas valve (see "**Gas pressure inlet check, adjustment of max. and min. gas pressure at the burner**");
- Check and, if required, modify the electronic adjustments of the boiler to adapt its operation to the specifics of the system (see "**Technical menu**");

### "Chimney cleaning function"

-  To start the combustion process diagnosis, pressing the  and  buttons simultaneously for 4 seconds, will the display allow the designation **C-5**. Subsequently, the boiler will start heating at maximum output. Before activating the chimney sweep function, make sure that the radiator valves or possible zone valves are open. To turn off the burner, exit the "chimney sweep" mode by pressing the .

Attention: the chimney sweep function is automatically deactivated after 240 seconds upon inactivity.

-  During the commencement of a new boiler, it is necessary to switch on the burner for 30 minutes before checking its operation since, during that period, vapours of possible production waste are produced that can falsify the flue gas readings.
- check the correctness of the overall operation of the boiler for heating and DHW;
  - Complete the necessary documentation and give a duplicate of it to the user.



**ATTENTION: The following operations must only be performed by a qualified technician.**



**After completing measurements and/or adjustments, do not forget to tighten the screws on the pressure connections and always check for gas leaks!**



Before operating the boiler, make sure that the circulation pump is not blocked due to a break in operation: unscrew the plug, and turn the rotor manually with a screwdriver or other suitable tool through the hole in the centre. Screw the plug back in, and make sure that the plug is not leaking.  
**Note: During the first 10 minutes, the burner re-ignition delay for heating may be in standby mode.**

- The motherboard makes the electrode perform several ignition attempts. This is done to ensure that the boiler only locks out in the event of a real, non-accidental problem.
- If air is present in the gas pipeline (e.g. in the event of a new system) it may be necessary to perform more than one start-up attempt.
- All boilers are regulated and tested at the factory to operate on the type of gas declared on the boiler nameplate. Starting up the boiler it is recommended to check if the regulation is correct in any case.

### Access to the internal parts of the boiler

1. Unscrew the screws **1**, which secure the top cover **2**;
2. Push panel **2** up and out and remove it from tabs **3**;
3. Unscrew the screws **4**, lift the control panel **5** and tip it downwards;
4. Unscrew the two screws **6** that secure the bottom of the cover, then pull it towards you. Then lift it upwards by unhooking it from the pins **3**;
5. After performing operations that require access to internal components, cover the boiler in reverse order, paying particular attention to fixing the top cover **2** to tabs **3**.

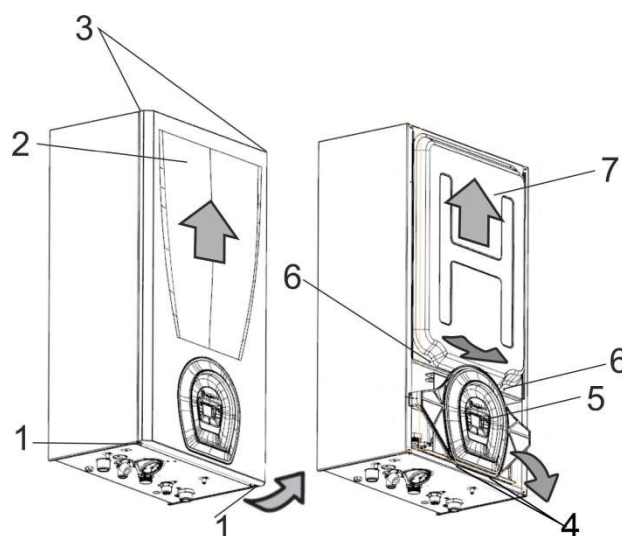

### Gas pressure inlet check, adjustment of max. and min. gas pressure at the burner

Dismantle the front faceplate (see "Access to internal parts of the boiler").

- (i)** Before switching on the boiler, ensure that the circulation pump is not blocked due to a break in operation: unscrew the plug, and turn the rotor manually with a screwdriver or other suitable tool through the hole in the centre. Screw the plug back in, ensuring that the plug is not leaking.

- (i)** Ensure that the produced heat can be utilized by radiators (and/or radiator panels/floor systems) or through the DHW circuit.

**Note:** The dynamic gas pressure must be measured during the operation at maximum output.

1. Loosen (turn 2-3 times) the screw on inlet **2** of the gas valve and connect the pressure gauge tube to it;

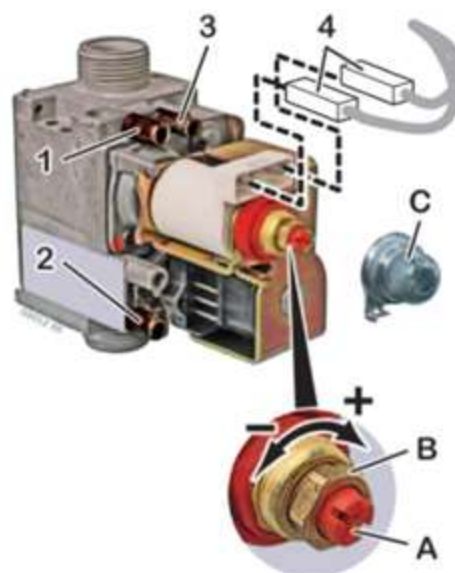

2. Check whether the measured pressure corresponds to the nominal pressure required for the inlet gas type (see "Technical information").
3. Close outlet **2** and check for gas leakage.

### Adjustment of max. and min. gas pressure at the burner

1. Loosen (turn 2-3 times) the screw on outlet **1** of the gas valve and connect the pressure gauge to it. In forced draught models, take out the silicone tube coming out of the sealed chamber from the "Vent" outlet **3**;
2. take out the protective cover **C**;
3. operate the boiler at maximum output, and activate the "chimney sweep" function by simultaneously pressing the **RESET** and **+|||** buttons for 4 seconds, the designation will appear on the display. **C-5**;
4. wait at least 10 seconds and check whether the **max.** pressure corresponds to the value indicated in the output adjustment table depending on the boiler model and the gas used;
5. adjust **max.** pressure by turning gasket **B** (10 mm), clockwise rotation increases the pressure, while counterclockwise rotation decreases it.;

6. take out one of connectors 4 of the modulating coil power supply; check if the measured pressure **min** corresponds to the value indicated in the output control table, depending on the boiler model and the gas used;
  7. adjust **min** pressure by rotating the screw **A** (with a 4 mm screwdriver), without moving the nut **B** at the same time. Clockwise rotation increases the pressure, counterclockwise rotation decreases it;
  8. reconnect connector 4 and check if the max. pressure has not changed, adjust if necessary;
  9. put the cap back on **C**;
  10. insert the tube into the "Vent" outlet 3 of the gas valve.
- ATTENTION:** after inserting the tube into the "Vent" outlet, the value determined by the pressure gauge may decrease due to pressure compensation. This phenomenon is natural and does not require adjustment;
11. tighten the screw on outlet 1 and check for gas leaks;
  12. to switch off the burner, exit the "chimney sweep" mode by pressing the button ;
  13. Assemble the front faceplate.



**Attention: Seal/Cover the GAS VALVE REGULATION UNIT AFTER EVERY ADJUSTMENT.**

### Conversion to an another type of gas



**WARNING: The following operations must only be performed by a specialized technician.**



**Contact the boiler manufacturer to supply the nozzles required for the conversion operations.**



**When operating the boiler on liquefied gas it is necessary to install a pressure reducer.**



**Cut the power off.**

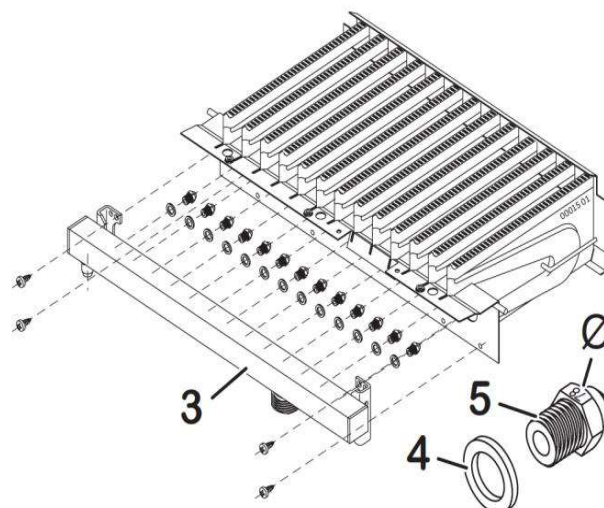

1. Dismantle the front faceplate and the sealed combustion chamber cover (see " Access to the internal parts of the boiler ");
  2. dismantle the burner;
  3. disconnect the tube connecting the gas valve to the ramp nozzle;
  4. dismantle the gas ramp **3** and replace the nozzles **5** suitable for the type of gas which is used. Install the new nozzles **with the supplied washers 4** (usually made of copper), even if the nozzles of the boiler standard equipment do not have washers originally;
  5. reassemble everything in reverse order, except the front faceplate;
6. switch on the boiler by pressing the  button in the heating mode. Activate the parameter "P00" (see "Parameter adjustments (technical menu)") and select the value corresponding to the type of gas, which is used:
    - **0 natural gas (G20),**
    - **1 liquefied gas (G30/G31)**

**(i)** Before switching on the boiler, ensure that the circulation pump is not blocked due to a break in the operation: unscrew the plug, turn the rotor manually with a screwdriver or other suitable tool through the hole in the centre. Tighten the plug, and ensure that the plug is not leaking.

**(i)** Make sure that the heat produced can be utilized by radiators (and/or radiator panels/floor systems) or through the DHW circuit.

**Note:** The dynamic gas pressure must be measured when the boiler is operating at the maximum output.

1. Loosen (turn 2-3 times) the screw on the inlet 2 of the gas valve and connect the pressure gauge tube to it;  
2. Make sure that the measured pressure corresponds to the nominal pressure required for the inlet gas type (see "Technical features");

3. Cover outlet 2 and check for any gas leakage.

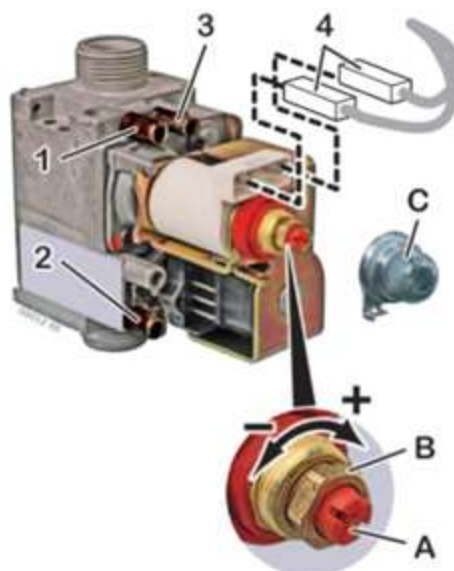



### Adjustment of the max and min gas pressure at the burner

1. Loosen (turn 2-3 times) the screw on outlet 1 of the gas valve and connect the pressure gauge to it. In forced draught models, dismantle the silicone tube coming out of the sealed chamber from the "Vent" outlet 3;

2. remove the protective cap C;

3. switch on the boiler at the maximum output, activate the "chimney sweep" function by simultaneously

pressing the  and  buttons for 4 seconds, on display will be shown C-5;;

4. wait at least 10 seconds and check that the **max.** pressure corresponds to the value indicated in the output adjustment table depending on the boiler model and the gas, which is used;

5. adjust the **max.** pressure by rotating the nut B (10 mm), clockwise rotation increases the pressure, counterclockwise rotation decreases the pressure;

6. remove one of the connectors 4 of the modulating coil supply; check whether the measured pressure at the **min** output corresponds to the value indicated in the output adjustment table, depending on the boiler model and the gas, which is used.;

7. adjust the **min** pressure by rotating the screw A (with a 4 mm screwdriver), paying attention not to move the nut B at the same time. Clockwise rotation increases the pressure, counterclockwise rotation decreases it;

8. reconnect the connector 4 and confirm whether the **max.** pressure has changed, adjust if necessary;

9. place the cap C;

10. assemble the tube into the "Vent" outlet 3 of the gas valve.

**ATTENTION:** after assembling the tube into the "Vent" outlet, the value determined by the pressure gauge may decrease due to pressure compensation. This is natural and does not require any adjustment.;

11. tighten the screw on outlet 1 and check for any gas leakage.;









12. to switch off the burner, exit the "chimney sweep" mode by pressing the  button once;

13. assemble the front faceplate.





**ATTENTION: COVER/SEAL THE GAS VALVE REGULATION UNIT AFTER EACH ADJUSTMENT.**





**Parameter adjustments (technical menu)**

Pressing the  and  buttons simultaneously for 4 seconds allows access to the parameter menu. In the parameter menu the symbols "P" and "00" will be displayed, every 3 seconds the parameter number and its value are alternately shown on the display. Press the  or  button to change the parameter number. To enter a parameter, press the button , the value of the parameter is changed by pressing the  and  buttons. Press the  button to save the selected value. To exit the technical menu, press the  button. If no action is performed for 240 seconds, the parameter menu is automatically closed without saving the changes.

Parameter number	Parameter designation	Factory setting	Adjustment range
<b>P00</b>	Type of gas	<b>0</b>	0 – Natural gas 1 – Liquefied gas
<b>P01</b>	Maximum heating output	<b>100%</b>	0% - 100%
<b>P02</b>	Burner ignition output	<b>40%</b>	0% - 100%
<b>P03</b>	Re-initiate time of the burner in heating mode	<b>3 minutes</b>	0 – 10 minutes
<b>P04</b>	Maximum output reaching time in heating mode	<b>3 minute</b>	0 – 10 minutes
<b>P05</b>	Pump "run out" time after performing the heating operation	<b>30 seconds</b>	0 – 180 seconds
<b>P06</b>	Pump "run out" time after performing DHW operation	<b>30 seconds</b>	0 – 180 seconds
<b>P07</b>	The delay time of the DHW flow meter	<b>1 second</b>	0 – 3 seconds
<b>P08</b>	Minimum operation time in heating	<b>0 second</b>	0 – 199
<b>P09</b>	Selecting the DHW on and off temperature	<b>0</b>	0 – off 1 – on
<b>P10</b>	Type of DHW flow	<b>20</b>	0-Flow switch 1-9 Unavailable 10-40 Flow rate sensor. DHW switching frequency in Hz
<b>P11</b>	Type of heating	<b>0</b>	0 – Radiator 1 – Not installed
<b>P12</b>	Fan "run out" time after performing heating or DHW operation	<b>10 seconds</b>	10 – 60 seconds
<b>P13</b>	Heating circuit outlet line temperature limit for DHW operation	<b>1</b>	0 – Disabled 1 – Enabled
<b>P14</b>	Outdoor air sensor correction	<b>20</b>	5-35
<b>P15</b>	Type of the boiler	<b>1</b>	0 - Bithermal 2 - Single circuit 1 – Dual circuit 3 – Only heating
<b>P16</b>	-	<b>Can not be changed.</b>	-
<b>P17</b>	-	<b>Can not be changed.</b>	-
<b>P18</b>	-	<b>Can not be changed.</b>	-
<b>P19</b>	-	<b>Can not be changed.</b>	-
<b>P20</b>	-	<b>Can not be changed.</b>	-

<b>P21</b>	Configuration of the display backlight	<b>0</b>	0 – Active for 60 seconds 1 – Active on demand  and  , active on standby 2 – Active
<b>P22</b>	Minimum heating output	<b>0%</b>	0% - 100%
<b>P23</b>	Temperature interval for switching on the burner	<b>0°C</b>	1-10°C

### Information menu

Pressing the  and  buttons simultaneously for 6 seconds allows access to the information menu. In the information menu the icons "∩" and "01" will be displayed indicating the activation of the information menu, every 3 seconds the parameter number and its value are alternately shown on the display. Press the  or  button to change the parameter number. To exit the technical menu, press the . If no action is performed for 240 seconds, the information menu closes automatically.

<b>Parameter number</b>	<b>Description</b>
∩ 01	Actual DHW temperature (°C)
∩ 02	Actual heating temperature (°C)
∩ 03	Actual outdoor air temperature (°C)
∩ 04	Estimated, set point temperature of the heating outlet line (°C)
∩ 05	Actual DHW flow rate (l/min)
∩ 06	Actual modulator current (mA)
-	-
-	-
-	-
-	-
∩ 11	The last error code
∩ 12	The second last error code
∩ 13	The third last error code
∩ 14	The fourth last error code
∩ 15	The fifth last error code

**Technical features**

<b>Parameters</b>	<b>Si units</b>	<b>VARME 12</b>	<b>VARME 18</b>	<b>VARME 24</b>	<b>VARME 28</b>	<b>VARME 32</b>
Nominal heating output of the system, max	kW	14.1	20.3	24.3	29.8	33.3
Nominal heating output of the system, min	kW	9.4	9.4	9.4	11.0	13.0
Heating output, min/max	kW	8.2/13	8.2/18.5	8.2/23.1	10.2/27.1	11.4/29.9
Efficiency (80/60°C)	%	92.0	92.0	92.0	92.0	92.0
NOX class	-	3	3	3	3	3
Flue gas temperature	°C	138	138	138	145	158
Energy efficiency class		A	A	A	A	A
<b>Heating circuit</b>						
Operating pressure, min	bar	0.5				
Operating pressure, max	bar	3				
Expansion tank capacity	liters	8				
Pre-pressure of the expansion vessel	bar	1				
Heating circuit temperature range	°C	35-80				
<b>DHW circuit</b>						
Hot water temperature range	°C	35-60				
Hot water flow rate, max	l/min	12.9	12.9	12.9	15.5	16.9
Hot water flow rate, nom	l/min	10.8	10.8	10.8	13.0	14.1
Hot water flow rate, min	l/min	2,5				
Water pressure at min/max	bar	0.5 ÷ 10				
<b>Electrical features</b>						
Voltage/frequency	V/Hz	230/50				
Power consumption, max	W	128	128	128	148	148
Protection class		IP42				
<b>Gas pressure and flow rate</b>						
Natural gas G20 (inlet pressure), min/max	mBar	13/20				
LPG G30/G31 (inlet pressure), min/max	mBar	30/37				
Gas flow rate G20	m <sup>3</sup> /h	0.9-1.6	0.9-2.3	0.9-2.76	1.0-3.4	1.2-3.7
Gas flow rate G30/G31	kg/h	0.5-0.8	0.5-1.2	0.5-1.5	0.5-1.8	0.6-2.1
<b>Overall Features</b>						
Weight	kg	29.2	29.2	29.2	34.3	34.3
Overall size	mm	708/412/260	708/412/260	708/412/260	708/412/351	708/412/351
Gross weight	kg	30.9	30.9	30.9	36.3	36.3
Package size	mm	781/466/314	781/466/314	781/466/314	783/468/401	783/468/401
Gas pressure G20 at the burner min/max	mbar	1.9/12	1.9/12	1.9/12	1.9/12	1.9/13
Gas pressure G30/G31 at the burner min/max	mbar	4.9/27.5	4.9/27.5	4.9/27.5	5/28	5/28

**Warranty card**

<b>Appliance model:</b>		<b>Serial number of the boiler</b>	
<b>Data of the sales organization</b>			
Name:		<b>Stamp location</b>	
Address:			
Phone number:			
Full name of the seller:			
Seller's signature:	Date of sale:		
<b>Customer data</b>			
Full name of the customer:			
Address:			
Phone number:			
I confirm that I have received the appliance in its entirety and agree to the warranty terms and conditions, I have no complaints about the appearance of the appliance. Customer's signature: _____			
<b>To be filled in by the organization that performed commissioning operations</b>			
<b>Organization data</b>			
Name:		<b>Stamp location</b>	
Address:			
Full name of the technician :			
Certificate number:			
<b>Appliance start-up date:</b>		<b>Technician's signature:</b>	
<b>Remarks during start-up:</b> _____ _____ _____			
Additional appliances:			
Dynamic gas pressure	mBar	Gas pressure at the burner min	mBar
Mains voltage:	V	Gas pressure at the burner max	mBar

**I hereby confirm that the appliance has been commissioned, is in good working order, and has been instructed in the rules of operation and safety. The operating instructions for the appliance have been received, the contents are clear and understandable, I agree and undertake to comply with the operating requirements. I am familiarized and agree with the manufacturer's warranty obligations.**

**Customer's signature:** \_\_\_\_\_



## About maintenance

For the boiler to operate reliably and efficiently, it must be systematically maintained at regular intervals. The frequency of maintenance depends on the specific installation and operating conditions, however in any case it is recommended that a qualified service technician performs the maintenance at least once a year. In the event of a repair or maintenance of structures close to the chimney and/or flue gas venting devices and their components, switch off the boiler and upon completion of the work, the qualified technician must check the operation of the boiler.

**Important note:** Before performing any operation for cleaning or maintaining the boiler, adjust the mode to **OFF**, and cut the power off and turn off the gas mains using the valve installed in front of the boiler. All maintenance and repair operations and combustion tests must be logged in the appliance passport together with the name of the person who performed the maintenance. If the equipment is not serviced or there is no record in the appliance passport of annual maintenance, the manufacturer has the right to refuse warranty repair. If the first start-up of the appliance was not performed by an authorized Service Center (no adjustments were made during the first start-up), the manufacturer also has the right to refuse warranty repair of the appliance.

## Operations to be performed during regular maintenance

- deoxidation of the burner;
- decalcification of the heat exchanger's interior parts (if necessary);
- inspection of flue gas bleeding vents and air intake ducts;
- inspection of the boiler's appearance;
- inspection of ignition, shut down and operation of the principles, both in DHW and heating modes;
- checking the tightness of connecting adapters and gas and water connection pipelines;
- checking gas consumption at maximum and minimum power;
- checking the position of the ignition-flame detection electrode;
- checking the operation of the safety mechanism in the event of a gas failure;
- combustion parameter test.

Do not clean the boiler or its parts with flammable substances (e.g. gasoline, alcohol, etc.). Do not clean panels, painted parts and plastic parts with paint thinners. The boiler cladding must be wiped with a damp rag. **After twelve (12) months from the commencement of the operation, and within 2 months, routine maintenance must be performed on the appliance.**

## Remarks on scheduled maintenance

Maintenance date	Name of organization	Full name of the technician	Contact number	Technician's signature

## Warranty conditions

*Federica Bugatti guarantees real quality. For installation, commissioning, subsequent maintenance and repair, it is recommended to contact an authorized Federica Bugatti Service Center. According to the contract with Federica Bugatti, the company will eliminate free of charge during the warranty period all the defects which occurred due to the fault of the manufacturer. The warranty period is 24 months from the date of putting the appliance into use, but not more than 27 months from the date of purchase by the owner of the appliance.*

*1. Regulations in the event of a handover of the equipment. 1.1. When purchasing the appliance, the owner inspects and checks the quality and completeness of the equipment. Claims on the appearance, presence of any external mechanical damage and incompleteness of the equipment after the sale. 1.2. Demand that the warranty card be filled out! 2. Installation and commissioning. 2.1. Installation and commissioning of the equipment are performed in full compliance with the manufacturer's instructions. 2.2. Installation and commissioning of the equipment must be performed by an authorized Federica Bugatti service centre or by a certified Federica Bugatti technician. 2.3 The company which performed the installation and commissioning of the appliance fills in the protocol (act) on the operations, which are performed and makes the appropriate marks in the warranty card. The warranty period for the appliance in the presence of a completed passport, sales and commissioning data, as well as a completed protocol (act) on the launch or commissioning of the appliance, is 24 months from the date of commissioning of the equipment, but not more than 30 months from the date of purchase of the equipment owner. Maintenance of the appliance. 3.1. After commissioning the device, the owner of the boiler is obliged to conclude a contract for annual maintenance of the appliance. For maintenance, it is recommended to contact Federica Bugatti authorized service centres, whose technicians are certified to perform the above-mentioned operations. The maintenance is performed in accordance with the manufacturer's instructions at least once a year, and in some cases, on the recommendation of the service organization, even more often, in accordance with the conditions of the used heating medium requirements and other features of the appliance operation, which differ from those declared by the manufacturer. 3.2 Please note that the installation, commissioning, maintenance and service works are performed on a reimbursable basis. 4. Warranty registration. 4.1. If a malfunction is detected, cut the power, switch the water and gas supplies off. Do not attempt to dismantle or repair the device by yourself. For prompt and quality maintenance or warranty repairs, please contact an authorized Federica Bugatti service centre in your area. In case of a situation detected by the authorized service centre regarding the appliance malfunction, which occurred due to the manufacturer's fault, the equipment is subject to warranty repair by replacing the defective part with the correct one. 4.3 Warranty claims of the company Federica Bugatti are accepted by authorized service organizations only if the following requirements are fulfilled: - commissioning is performed by an authorized Federica Bugatti service centre or by a certified Federica Bugatti technician; - all the fields of the warranty card are correctly filled in date of sale and seller's stamp, the model with the factory number of the product, date of commissioning, installation and commissioning mark (to be filled in by the service technician at the time of installation and commissioning); the commissioning protocol (act) of the appliance; - the power supply system, fuel supply system, heating medium, as well as the ventilation system of the combustion products filled in. 4.4 Warranty obligations shall be invalidated in the following cases: - the product was not used for its intended purpose; - the conditions of herein the warranty are not fulfilled; - mechanical or thermal damage is detected on the appliance body, as well as traces of liquid, dirt and dust, which could be the cause of a part failure or an inoperability of the appliance; - installation, commissioning, maintenance, repair of the appliance were performed by unauthorized persons; - making design changes on the appliance. 4.5. To ensure more reliable operation of the appliance in accordance with the local operating conditions (parameters of the electricity, gas, and water supplies) and prevent malfunctions, it is recommended that installing additional components: voltage stabilizer, surge protector, dielectric on the gas pipe, filtration system, etc. 4.6. Federica Bugatti does not assume any other obligations or responsibilities than those stated herein the warranty obligations. The current addresses of the service centres can be found on the website:*

<http://www.federicabugatti.com>



FEDERICA BUGATTI LLC.  
MANUFACTURER: VARMECOM INC., MADE IN TURKEY

[FEDERICABUGATTI.COM](http://FEDERICABUGATTI.COM)